

Series TB100

Double Row Terminal Blocks

SPECIFICATIONS

Rating: 30A, 300V*

Center Spacing: .375" or 3/8" (9.52 mm)

Wire Range: #14 - 22 AWG CU

Screw Size: #6-32 philslot screws

Torque Rating: 9 in-lb.

Distance Between Barriers: .30" (7.62 mm)

Mounting: #6 screws

Operating Temperature: 130°C (266°F) max., -40°C (-40°F) min.

Materials: Molded base: Black, UL rated 94V0 thermoplastic

Terminal plating: Tin over brass; Screws: Zinc plated steel

Breakdown Voltage: 3600V

Agency Information: UL/CSA; IEC Compliance;

CE Certified

* Max. rating shown; some options may be rated lower - consult factory.



Poles	A	B	Poles	A	B	Poles	A	B
02	1.40	1.12	14	5.90	5.62	26	10.40	10.12
03	1.78	1.50	15	6.28	6.00	27	10.78	10.50
04	2.16	1.88	16	6.66	6.38	28	11.16	10.88
05	2.53	2.25	17	7.03	6.75	29	11.53	11.25
06	2.90	2.62	18	7.40	7.12	30	11.90	11.62
07	3.28	3.00	19	7.78	7.50	31	12.28	12.00
08	3.66	3.38	20	8.16	7.88	32	12.66	12.38
09	4.03	3.75	21	8.53	8.25	33	13.03	12.75
10	4.40	4.12	22	8.90	8.62	34	13.40	13.12
11	4.78	4.50	23	9.28	9.00	35	13.78	13.50
12	5.16	4.88	24	9.66	9.38	36	14.16	13.88
13	5.53	5.25	25	10.03	9.75			

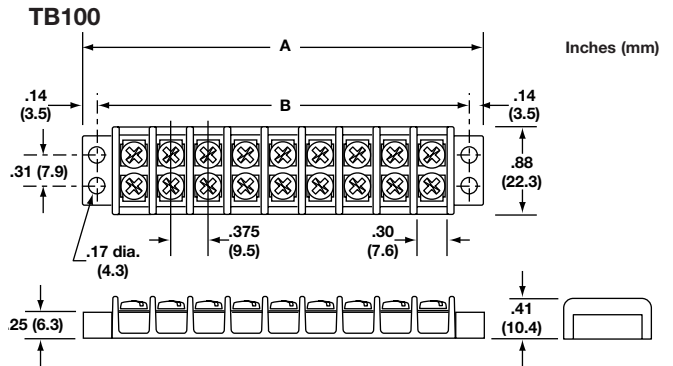

* Dimensions in inches. To convert to millimeters, multiply by 25.4.

Part Numbering System

Series

T B 1 0 0

Poles

□ □

02 to 36

Screw Options

□ □

Blank - steel philslot, zinc plated
00 - screws shipped bulk
B - brass philslot, nickel plated
BS - brass Sems philslot, nickel plated
SP - steel Sems philslot, zinc plated
P - steel Sems (P-style)
ST - stainless steel, philslot
STR - stainless steel, phillips (recess)

Marking

□ □

L1 to L6 - (pg 35)
 Marker strips (pg 36)
 Covers (pg 35)

Hardware Options

□ □ □ □

QC1 to QC20 - quick connects
J101 - flat slip-on jumper
 (2 position only)
OJ2 - over barrier jumpers
OJ4 - over barrier jumpers

Screw Options



B
Brass Philslot
Nickel Plated



BS
Brass SEMS
Philslot Nickel Plated



SP
Steel SEMS
Philslot Zinc Plated



P
Steel SEMS
(P-Style)



ST
Stainless Steel
Philslot



STR
Stainless Steel
Phillips (recess)

Hardware Options

Quick Connects – Assembled Terminals .187" x .020". Max. current rating 13 Amps. For other orientations, contact factory.

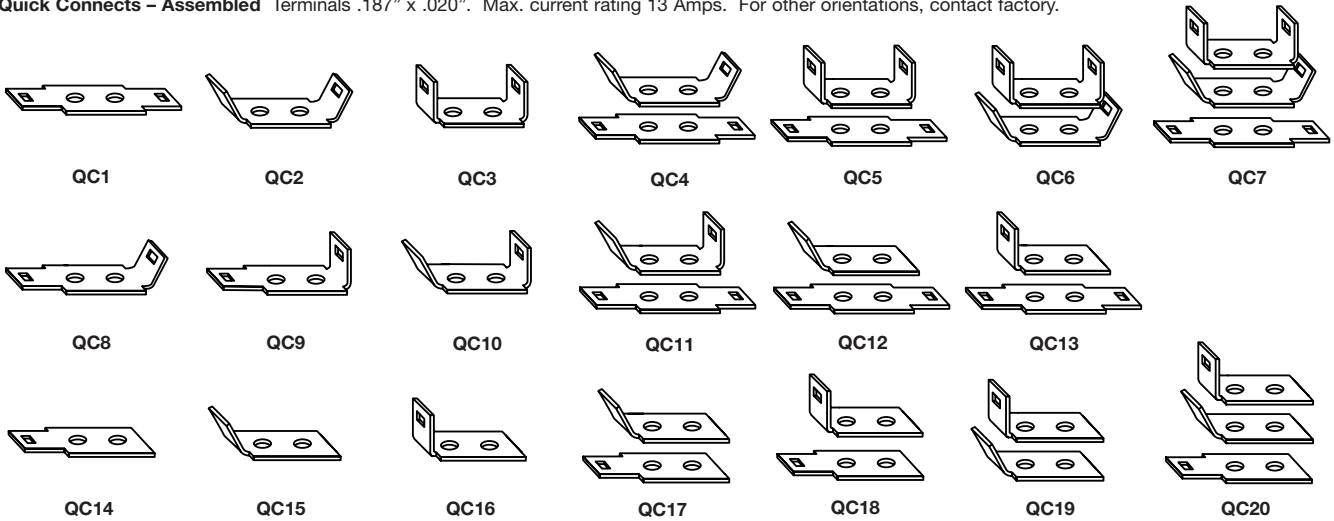

Quick Connects – Bulk Min. order per part no. – 100 pieces.

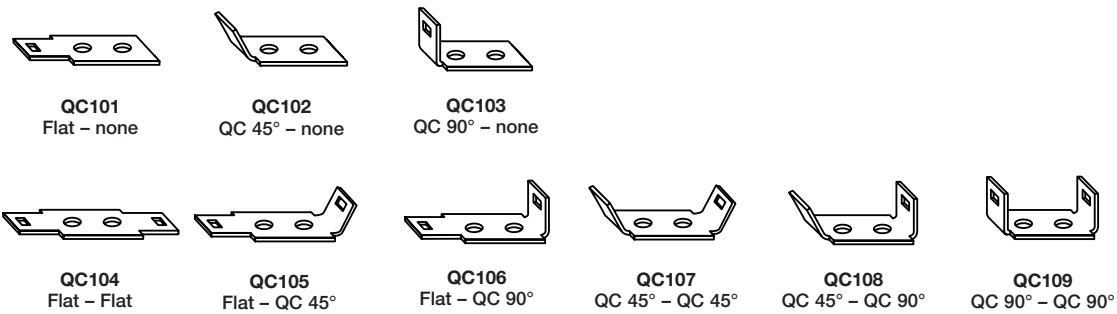

Jumpers – Bulk Min. order per part no. – 100 pieces. Contact factory for jumper assembly.



Series TB200 & TB200HB Double Row Terminal Blocks

SPECIFICATIONS

Rating: TB200 - 30A, 300V*

TB200HB - 30A, 600V*

Center Spacing: .437" or 7/16" (11.10 mm)

Wire Range: #12 - 22 AWG CU

Screw Size: #6-32 philslot screws

Torque Rating: 9 in-lb.

Distance Between Barriers: .353" (8.97 mm)

Mounting: #6 screws

Operating Temperature: 130°C (266°F) max., -40°C (-40°F) min.

Materials: Molded base: Black, UL rated 94V0 thermoplastic

Terminal plating: Tin over brass; Screws: Zinc plated steel

Breakdown Voltage: 4800V

Agency Information: UL/CSA; IEC Compliance;
CE Certified

* Max. rating shown; some options may be rated lower - consult factory.

Poles	A	B	Poles	A	B	Poles	A	B
02	1.63	1.31	12	6.00	5.68	22	10.37	10.06
03	2.07	1.75	13	6.44	6.12	23	10.81	10.50
04	2.51	2.18	14	6.87	6.56	24	11.25	10.93
05	2.94	2.62	15	7.31	7.00	25	11.68	11.37
06	3.38	3.06	16	7.75	7.43	26	12.12	11.81
07	3.82	3.50	17	8.19	7.87	27	12.56	12.25
08	4.25	3.93	18	8.62	8.31	28	13.00	12.68
09	4.69	4.37	19	9.06	8.75	29	13.44	13.12
10	5.13	4.81	20	9.50	9.18	30	13.87	13.56
11	5.57	5.25	21	9.94	9.62			

* Dimensions in inches. To convert to millimeters, multiply by 25.4.

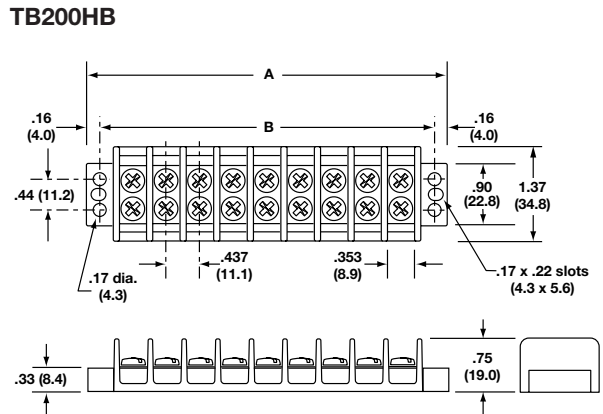
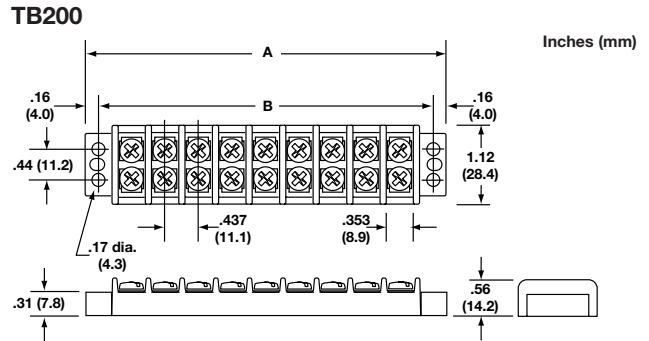
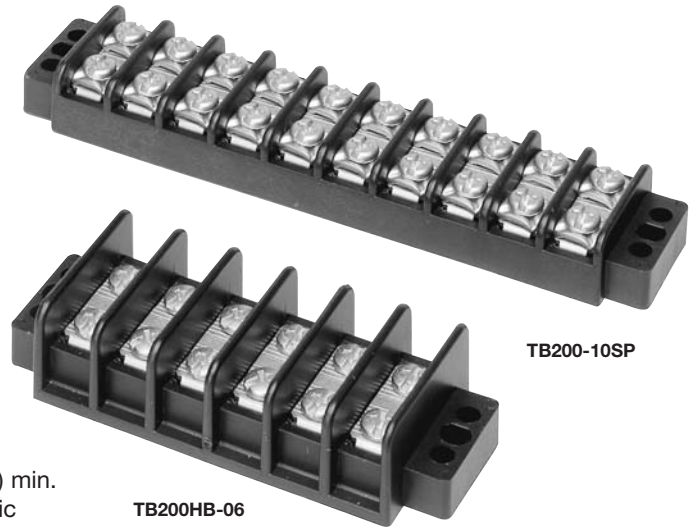

Part Numbering System

Series



200 - Standard
200HB - High barrier

Poles



02 to 30

Screw Options



Blank - steel philslot, zinc plated
00 - screws shipped bulk
B - brass philslot, nickel plated
BS - brass Sems philslot, nickel plated
SP - steel Sems philslot, zinc plated
P - steel Sems (P-style)
ST - stainless steel, philslot
SS - stainless steel Sems, philslot
STR - stainless steel, phillips (recess)

Marking



L1 to L6 - (pg 35)
Marker strips (pg 33)
Covers (pg 32)

Hardware Options



QC1 to QC20 - quick connects
J201 - flat slip-on jumper
(2 position only)
OJ3 - over barrier jumpers
OJ5 - over barrier jumpers
OJ7 - over barrier jumpers

Screw Options

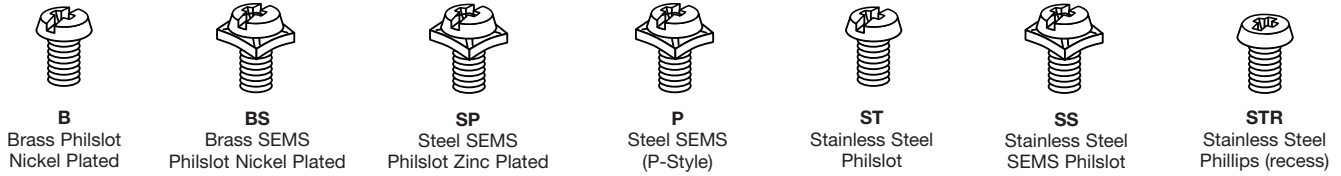

Hardware Options

Quick Connects – Assembled Terminals .250" x .031". Max. current rating 20 Amps. For other orientations, contact factory.

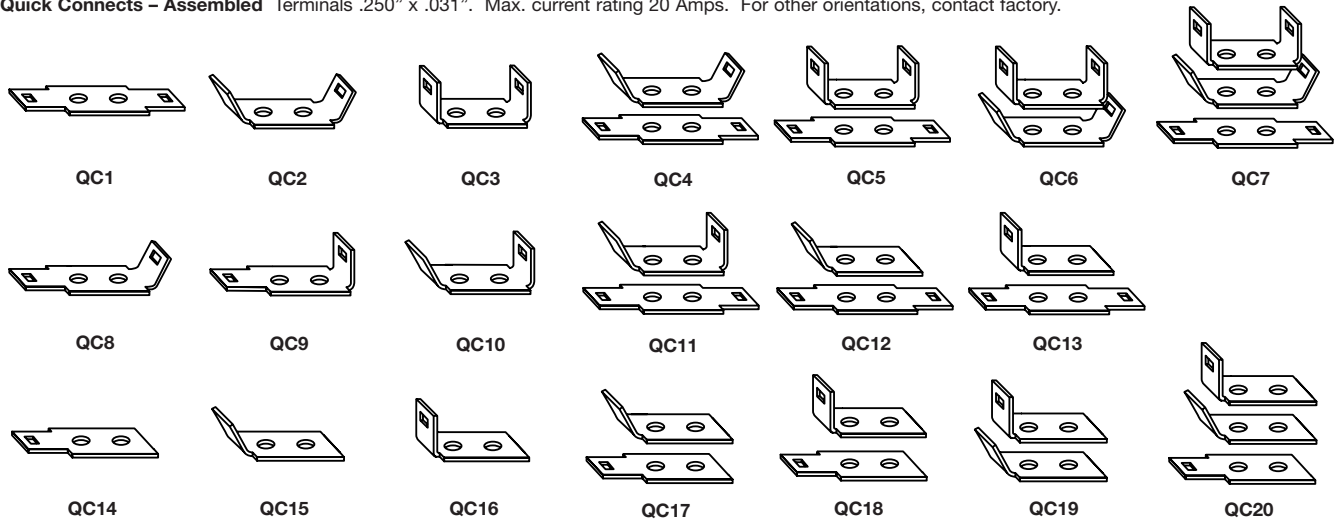

Quick Connects – Bulk Min. order per part no. – 100 pieces.

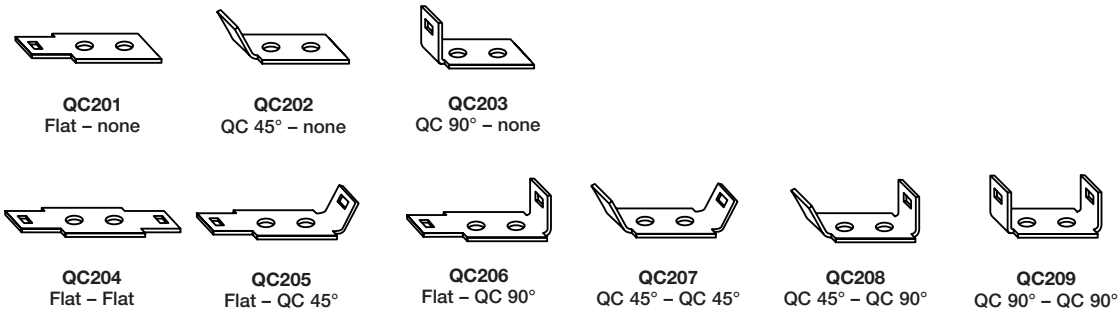

Jumpers – Bulk Min. order per part no. – 100 pieces. Contact factory for jumper assembly.



Series TB300 & TB345

Double Row Terminal Blocks

SPECIFICATIONS

Rating: TB300 – 30A, 600V*

TB345 – 45A, 600V*

Center Spacing: .562" or 9/16" (14.28 mm)

Wire Range: #8 - 22 AWG CU

Screw Size: TB300 – #8-32 philslot screws

TB345 – #10-32 philslot screws

Torque Rating: #8 screws - 16 in.-lb.;

#10 screws - 20 in.-lb.

Distance Between Barriers: .41" (10.5 mm)

Mounting: TB300 – #8 screws; TB345 – #10 screws

Operating Temperature: 130°C (266°F) max., -40°C (-40°F) min.

Material: Molded base: Black, UL rated 94V0 thermoplastic

Terminal plating: Tin over brass; Screws: Zinc plated steel

Breakdown Voltage: 7500V

Agency Information: UL/CSA; IEC Compliance;

CE Certified

* Max. rating shown; some options may be rated lower - consult factory.



Poles	A	B	Poles	A	B	Poles	A	B
02	2.13	1.69	10	6.62	6.19	18	11.12	10.68
03	2.69	2.25	11	7.18	6.75	19	11.68	11.25
04	3.25	2.81	12	7.75	7.31	20	12.24	11.81
05	3.81	3.37	13	8.31	7.87	21	12.80	12.37
06	4.37	3.94	14	8.87	8.44	22	13.37	12.93
07	4.94	4.50	15	9.43	9.00	23	13.93	13.50
08	5.50	5.06	16	9.99	9.56	24	14.49	14.06
09	6.06	5.62	17	10.56	10.12			

* Dimensions in inches. To convert to millimeters, multiply by 25.4.

TB300 & TB345

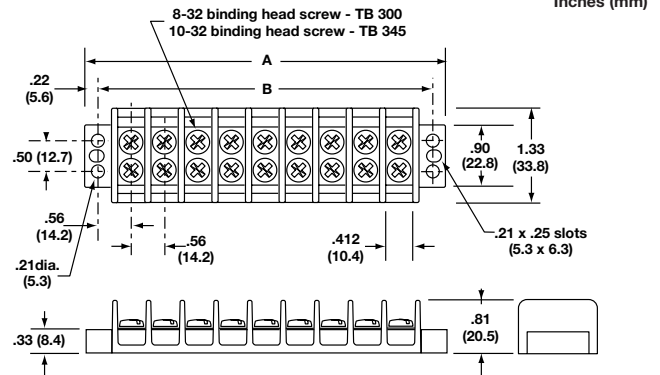

Part Numbering System

Series



300 - 8-32 screw
345 - 10-32 screw

Poles



02 to 24

Screw Options



Blank - steel philslot, zinc plated
00 - screws shipped bulk
B - brass philslot, nickel plated
BS - brass Sems philslot, nickel plated (TB300 only)
SP - steel Sems philslot, zinc plated
P - steel Sems (P-style)
ST - stainless steel, philslot
STR - stainless steel, phillips (recess)

Marking



L1 to L6 - (pg 35)
Marker strips (pg 36)
Covers (pg 35)

Hardware Options



QC1 to QC20 - quick connects (TB300 only)
J301 - flat slip-on jumper
OJ6 - over barrier jumper
OJ11 - over barrier jumper

Screw Options



B
Brass Philslot
Nickel Plated



BS
Brass SEMS
Philslot Nickel Plated



SP
Steel SEMS
Philslot Zinc Plated



P
Steel SEMS
(P-Style)



ST
Stainless Steel
Philslot



STR
Stainless Steel
Phillips (recess)

Hardware Options

Quick Connects – Assembled TB300 only. Terminals .250" x .031". Max. current rating 20 Amps. For other orientations, contact factory.

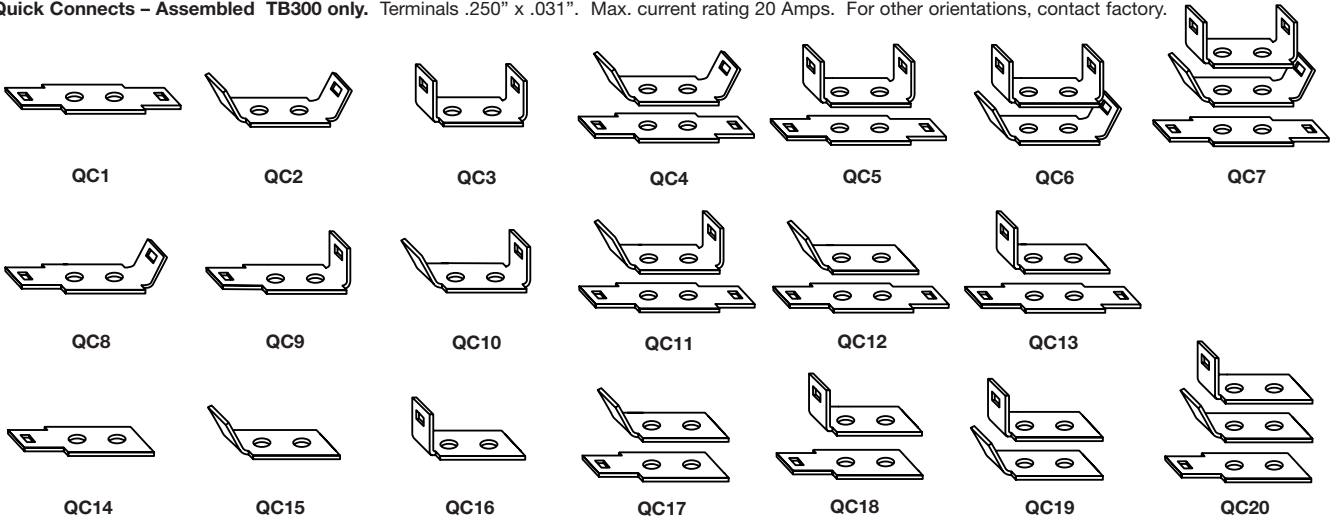

Quick Connects – Bulk *TB300 only. Min. order per part no. – 100 pieces.

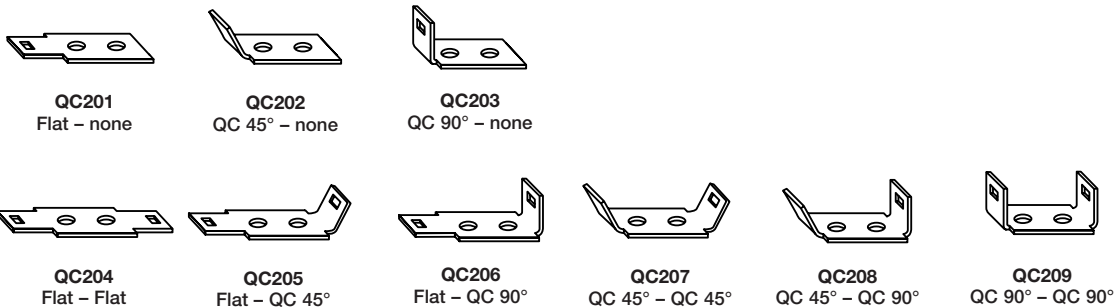

Jumpers – Bulk Min. order per part no. – 100 pieces. Contact factory for jumper assembly.

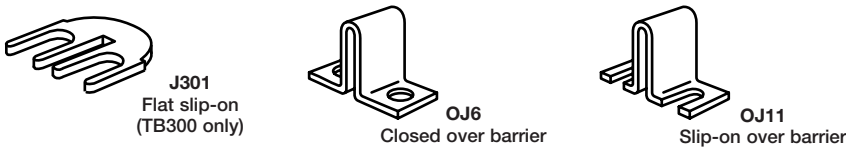

Series TB400

Double Row Terminal Blocks

SPECIFICATIONS

Rating: 75A, 600V

Center Spacing: .687" or 11/16" (17.45 mm)

Wire Range: #6-14 AWG CU

Screw Size: #10-32 philslot screws

Torque Rating: 20 in-lb.

Distance Between Barriers: .56" (14.3 mm)

Mounting: #10 screws

Operating Temperature: 130°C (266°F) max., -40°C (-40°F) min.

Material: Molded base: Black, UL rated 94V0 thermoplastic

Terminal plating: Tin over brass; Screws: Zinc plated steel

Breakdown Voltage: 7500V

Agency Information: UL/CSA; IEC Compliance;
CE Certified



TB400-05

Poles	A	B	Poles	A	B	Poles	A	B
02	2.51	2.06	06	5.26	4.81	10	8.01	7.56
03	3.20	2.75	07	5.95	5.50	11	8.70	8.25
04	3.89	3.44	08	6.64	6.19	12	9.39	8.94
05	4.58	4.13	09	7.33	6.88			

* Dimensions in inches. To convert to millimeters, multiply by 25.4.

TB400

Inches (mm)

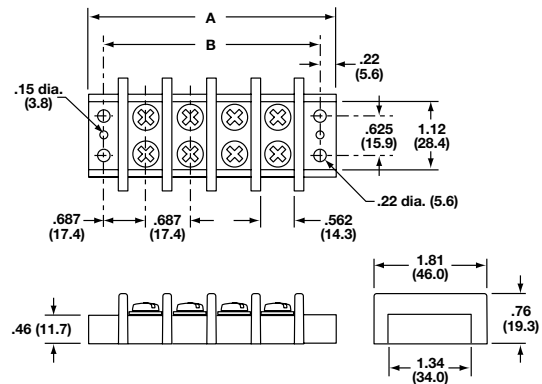

Screw Options



B
Brass Philslot
Nickel Plated



ST
Stainless Steel
Philslot



STR
Stainless Steel
Phillips (recess)

Hardware Options

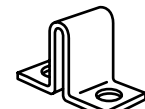

OJ14
Closed over barrier

Part Numbering System

Series

T B 4 0 0

Poles

□ □

02 to 12

Screw Options

□ □

Blank - steel philslot, zinc plated
00 - screws shipped bulk
B - brass philslot, nickel plated
ST - stainless steel, philslot
STR - stainless steel, phillips (recess)

Marking

Not available

Marking Options & Accessories

Double Row Terminal Blocks (TB100, TB200, TB300, TB345 SERIES)

Marking Options

Standard Marking

Standard markings are applied directly to the side(s) of a block. Standard color is white. Standard height is .125".

Note: Blocks marked on both sides require a different code for each side. Example Style L1 on one side of the block requires Style L2 on the other side to ensure common terminal marking. To order, add appropriate suffix (L1, L2, L3, L4, L5 and/or L6) to block part number in the proper sequence.

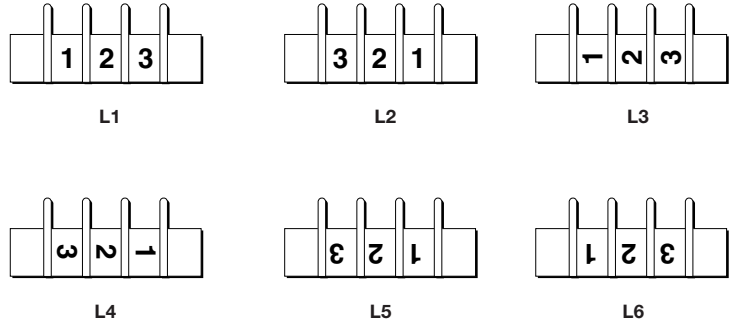

Special Marking

Special markings are available at an additional charge for preparation. Production charges for setup, handling and marking are the same as for standard marking. Drawing(s) must be submitted to ensure accuracy of part required. Consult factory for price and delivery.

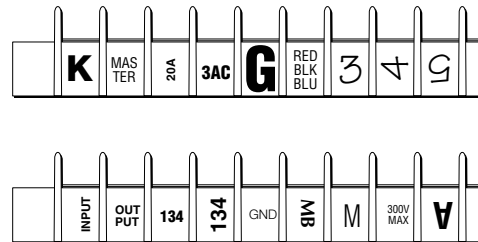

Note: Marking is not available on TB400 Series

Covers

Covers prevent personnel, screws and foreign items from contacting live terminals. Available in white or clear plastic. Two cover clips supplied with each cover. Cover width is 1.31 inches.

All covers must be ordered separately. Consult factory for special legends.

Example: 10 position cover, white, TB100 Series, no legends . . . Part No. is X12010.

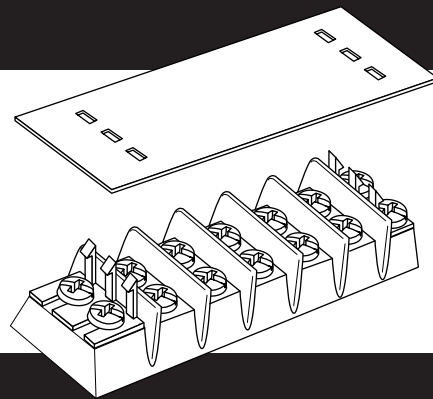

Part Numbering System

Series



Cover Strip



120 - TB100/white
119 - TB100/clear
220 - TB200 - white
220HB - TB200HB - white
219 - TB200 - clear
219HB - TB200HB - clear
320 - TB300 & TB345 - white
319 - TB300 & TB345 - clear

Poles



02 to 36 (TB100)
02 to 30 (TB200/TB200HB)
02 to 24 (TB300/TB345)

Cover Clips – Bulk

Part Number

DD1 - TB100 Series
DD2 - TB200 Series
DD2HB - TB200HB Series
DD3 - TB300 Series

Note: Covers are not available on TB400 Series.

Top & Bottom Marking Strips

Double Row Terminal Blocks (TB100, TB200, TB300, TB345 SERIES)

TOP MARKER STRIPS

Top mounting marker strips are available in white (opaque) plastic. Two cover clips are supplied with each marker strip.

All top marker strips must be ordered separately. Consult factory for special legends.

Example: 12 position cover, TB200, .032" x .312", with no legends . . . Part No. is X20312.

Example: 12 position cover, TB200HB, .060" x .500", with no legends . . . Part No. is X23312HB.

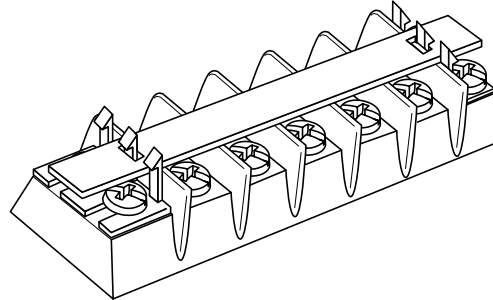

Part Numbering System

Series



Top Marker Strip



133 - TB100 (.060 thk x .500w)
103 - TB100 (.032 thk x .312w)
233 - TB200 (.060 thk x .500w)
233TB - TB200HB (.060 thk x .500w)
203 - TB200 (.032 thk x .312w)
203HB - TB200HB (.032 thk x .312w)
333 - TB300 & TB345 (.060 thk x .500w)
303 - TB300 & TB345 (.032 thk x .380w)

Poles



02 to 36 (TB100)
02 to 30 (TB200/TB200HB)
02 to 24 (TB300/TB345)

Note: Marking Strips are not available on TB400 Series.

BOTTOM MARKER STRIPS;

Bottom mounting marker strips are made of black PVC, .030" thick. Space is available to handle most marking situations. All marker strips must be ordered separately.

To order, specify part number, required legends and (BF) bottom forward, (BR) bottom reverse, (TF) top forward, or (TR) top reverse. Consult factory for specials.

Example: 13 position strip, TB100 with no legends, space for marking one side . . . Part No. is X10513.

Position for legends (one side, two sides) can be specified standard. Standard legend height is .125". Standard legends are 0-99 and A-Z. Special legends are available on special order. Drawing(s) must be submitted to ensure accuracy of part required.

Space for marking one side



Space for marking two sides



	TB100	TB200	TB200HB	TB300	TB345	TB400
Dim. A	1.13"	1.37"	1.62"	1.58"	1.58"	N/A
Dim. B	1.38"	1.62"	1.81"	1.81"	1.81"	N/A

Part Numbering System

Series



Bottom Marker Strip



105 - TB100 - marking one side
101 - TB100 - marking both sides
205 - TB200 - marking one side
201 - TB200 - marking both sides
295 - TB200HB - marking one side
291 - TB200HB - marking both sides
305 - TB300 & TB345 - marking one side
301 - TB300 & TB345 - marking both sides

Poles



02 to 36 (TB100)
02 to 30 (TB200/TB200HB)
02 to 24 (TB300/TB345)

Orientation



BF - bottom forward
BR - bottom reverse
TF - top forward
TR - top reverse

Note: Marking Strips are not available on TB400 Series.

Series KU

Base Mount Double Row Terminal Blocks

SPECIFICATIONS

Rating: 60A, 600V*

Center Spacing: .625" (15.88 mm)

Number of Poles: 2-12

Wire Range: #6-22 AWG CU

Screw Size: #10-32 brass nickel plated

Torque Rating: 20 in-lb.

Distance Between Barriers: .437" (11.09 mm)

Mounting: Base mount. For 35mm DIN rail mountable, add ND prefix

Material: Molded base: Black, UL rated 94V0 thermoplastic

Terminal plating: Nickel over brass

Operating Temperature: 105°C max.

Agency Information: UL/CSA; CE Certified

* 60A rating achieved with #6 copper wire crimped to ring terminal.

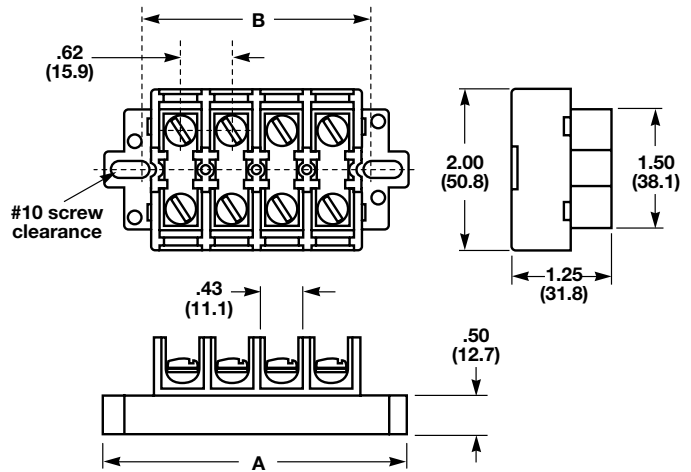
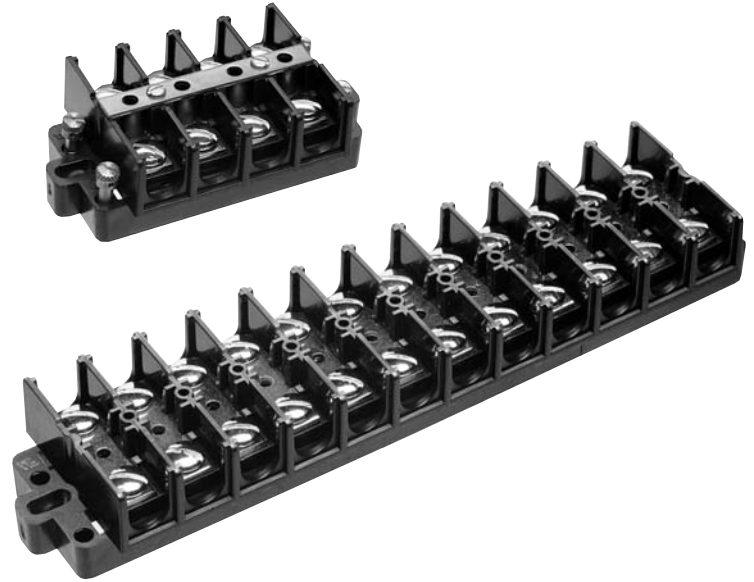

Poles	KU		KUX only A
	A	B	
02	2.50	1.62	2.00
03	3.12	2.25	2.62
04	3.75	2.87	3.25
05	4.37	3.50	3.87
06	5.00	4.12	4.50
07	5.62	4.75	5.12
08	6.25	5.37	5.75
09	6.87	6.00	6.37
10	7.50	6.62	7.00
11	8.12	7.25	7.62
12	8.75	7.87	8.25

* Dimensions in inches. To convert to millimeters, multiply by 25.4.

Part Numbering System

Series



- KU** - standard block
- KUH** - block
- KUX** - short block
- KUSC** - standard w/shorting strap & 4 shorting screws
- KURL** - standard w/removable link
- KUXSC** - short block w/shorting strap & 4 shorting screws
- KUXRL** - short block w/removable link

Poles



02 to 12

Screw Options



- 00** - screws shipped bulk
- W** - brass washer head, nickel plated
- P** - steel screw w/pressure plate zinc plated
- B** - brass washer head, no plating
- BP** - brass phillslot, nickel plated

Covers



WC - Top cover & 2 end plates

Marking Strip



- MT** - matte finish
- NU** - Numbered 1 to 12, horizontal
- NUV** - numbered 1 to 12, vertical
- PT** - marker strip for cover

Accessories

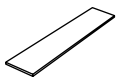

MTMU##
Molded Marking Tape
Matte Finish

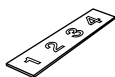

NUM##
Molded Marking Tape

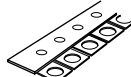

JU12
Jumper
12 Circuits

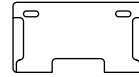

NUE
End Piece for NUC

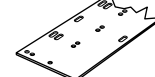

NUC##
Cover